

## Home Automation System And Security System Using GSM

\*Gauri Sunil Kakade<sup>1</sup>, Prof Dr S.V. Kurundhkar<sup>2</sup>

<sup>1</sup>Department of Electronics and Telecommunication Engg. Vishwakarma Institute of Technology Pune, India

<sup>2</sup>Department of Electronics Engg. Vishwakarma Institute of Technology Pune, India

Corresponding Author: Gauri Sunil Kakade

**Abstract:** Human life in the present runway is an extremely distressing system. Ordinarily, when we go out, we neglect to keep the house electric machine, gas catch, closed down the screen, home security can't be taken note. Arrangement is the home mechanization framework. (Automation is a framework in which you can keep our home and office from any area). Because of this above, we have a Home Computerization framework usage that will be done in the correct path with Home Machines and Home Security Handle. In this paper we present GSM based Home Computerization Framework in which we control the home apparatuses and keep up security framework. This framework will be the commitment of power for perusing power. We live in the realm of instabilities. Security has turned out to be a standout amongst the most essential and essential worry in our everyday life. There is dependably a component of risk in each point. Here and there it is conceivable to keep away from these conditions. We can control the greatness of the demolition caused on the off chance that it is most certainly not. Numerous mechanization frameworks are being produced in the home computerization framework. The forte of our venture execution is straightforward, simple to deal with, less convoluted outline, influence sparing framework and less cash to actualize. This is moderate regular man

Date of Submission: 00-00-0000

Date of acceptance: 00-00-0000

### I. Introduction

The idea of home Automation has been around since the late 1970s. In any case, with the progression of innovation and administrations, individuals' desires of what a home ought to do or how the administrations ought to be given and gotten to at home has changed a great deal over the span of time, thus has home mechanization frameworks. On the off chance that we take a gander at various home computerization frameworks after some time, they have constantly attempted to give effective, advantageous, and safe courses for home tenants to get to their homes. Regardless of the adjustment in client desires, progression of innovation, or change of time, the part of a home mechanization framework has continued as before. Planning a home mechanization framework for checking and controlling different gadgets in remote areas should be possible through an assortment of correspondence choices, for example, remote LAN advancements, dial-up modems, private radio systems, satellite correspondence, GSM

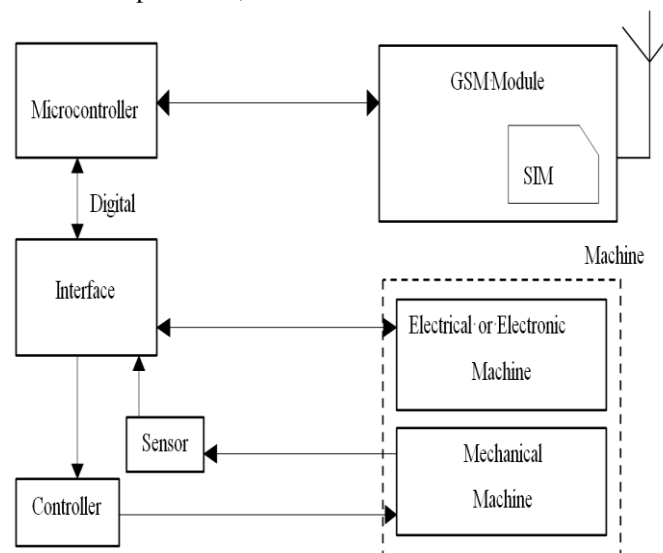

Fig 1, General Home Automation System

Mobile based home mechanization is alluring to specialists in view of the prevalence of cell phones and GSM innovation. We for the most part consider three choices for correspondence in GSM, in particular SMS-based home mechanization, GPRS-based home computerization, and Double Tone Multi Recurrence (DTMF)-based home Automation Figure [1]. It demonstrates the coherent graph of how a home's sensors, electrical, and mechanical gadgets collaborate with the home system and imparts through the GSM module utilizing an Endorser Character Module(SIM). The framework changes over the machine capacities into electrical flags through a transducer, which goes into a microcontroller. A transducer changes over physical amounts like sound, temperature, and mugginess into some other amount like voltage; here, a sensor does that capacity. For electronic gadgets, their perusing goes specifically into the microcontroller. The microcontroller examinations these signs and changes over them ++into orders that can be comprehended by the GSM module. In view of the got summons, the GSM module chooses the suitable specialized technique (SMS, GPRS or DTMF). In spite of the fact that utilizing GSM arrange has all these vital points of interest over other specialized strategies, it would be a repetitive, time and cash expending undertaking for the client to utilize his cell phone each time he/she needs to speak with the framework when the client is as of now at home. So we recommended and executed another strategy which utilizes the voice of the client to control the framework. In our model, the client can communicate with the framework by giving orders with his/her cell phone. This strategy extraordinarily streamlines the communication with the machines when the client is at

## **II. Litratue Review**

Subhas C. Mukhopadhyay et al. [1] presents survey of a few remote sensors, which are utilized for home checking especially to care for matured individuals. The observing framework is set up on the blend of a few sensors, and it has the capacity of broadcasting information by means of remote correspondence. The focal processor gathers information and stores all information for current prerequisite and for future reason. The framework stores the propensity for way of life of a man. The framework contrasts gathered information and put away example, which relies on upon circumstances and activities are as of now characterized like irregular or strange. In the event of any anomalous action, the framework distinguishes it and produces a disturbing or cautioning or SMS and it is transmitted to the parental figure. This remote detecting framework is accessible for this sort of use with minimal effort and can possibly spare human existences of seniority individuals. Wei-Chung Teng et al. [2] proposed the plan and usage of a private portal: My Server, which gives home security administrations. The framework driven by peripherals associated through WSNs. My Server basic intended to work on Message Arranged Middleware (Mother) with six obviously characterized center administration modules Sukun Kim et al. [3] display a dynamic research in a WSN for Auxiliary Wellbeing Observing (SHM). Prerequisites are recognized to get information for adequate quality to have a genuine logical incentive to the scientists for basic wellbeing observing. The gathered information matches with hypothetical models and also with past investigations of the scaffold. The sending is the greatest WSN for SHM.

Alan Mainwaring et al. [4], gives a profundity think about as to of WSNs to genuine condition territory observing. The created framework covers the equipment plan of hubs and sensor organize for remote get to and its administration. Design of framework is proposed to manage the prerequisites of natural surroundings observing. The case of framework engineering for checking of ocean winged creature settling condition and exercises is exhibited. According to and by instilment, the system has 32 notes on a little island off the shoreline of Maine valuable live information on web. The application driven outline serves to distinguish essential zones of extra work in interchanges, arrange re entrusting, information testing, and wellbeing observing. Huiping Huang et al. [4], presents a remote home security alert framework with an answer for set-up Low power utilization. The framework distinguishes s the burglary, fir, and spillage of crude gas by utilizing the WSN and GSM innovation. If there should arise an occurrence of any variation from the norm, the framework sends caution message remotely. The single chip C5081F310 is equipment of the framework, which imparts by means of remote utilizing chip CC1100withSIMENS TC35 GSM module. The product of the framework created utilizing C51 dialect, which has capacity of get-together, getting and sending information by means of remote. If there should be an occurrence of recognition of some hazardous condition, it sends disturbing SMS to clients of 35 mobilephone. With simple utilization preferences, low-control utilization, unwavering quality, and supplement remote, this framework can be utilized for functional incentive in different fields as well

Jianjun Chen et al. [5], by utilizing othe-rack WLAN segments, those are monetarily accessible, portrayed usage of indoor reconnaissance framework. This security framework continually examined nature. It had the capacity to convey constant caution motions on the premise of identified changes in the got flag quality esteems. The test comes about demonstrated promising interruption location abilities however the correct execution impediment and quality of this observation framework is yet to be explored Yousouf Zatout et al. [6] display arrangement of sparing the vitality of remote sensor in a blended situation for Home Checking. It recommends an outline and a usage of three –tier sensor organize arrangement, which utilizes vitality effectively for home applications. The system comprises of heterogeneous sensors e.g. ecological, restorative, and

video/sound sensors. The base arrangement is to sort out the sensors into various gatherings according to their specific capacities and parts. As indicated by wise conduct of the sensor, the action term and correspondence are diminished in the meantime. Yanjun Li. [7] portrayed an outline of a novel receptive WSN for observing out of control fire and assessed power, reactivity, life span, and unwavering quality of the system. The commitment of the paper is to outline a sensor organize that can meet the objective of unwavering quality, reactivity, and that demonstrates worthy vigor and moderately longer life time arrange life. A. Gad dam et al. [8] presents savvy advanced home observing framework by utilizing a bed sensor coordinated with a remote gadget. The Based framework that utilizations remote sensors to screen electrical apparatuses, for instance is it shut or open. To make the framework edibles by including sensors of various sorts Utilizing particular action observing (SAM) framework

**Review of Different Protocol**

	Zigg-Bee	X10	GSM
Inventor	ZigBee Alliance	Pica Electronics	ETS
standardization	IEEE802.15.4	Proprietary	ETS
Primary Market	Industrial automation	Home Automation	Communi-on
Com Mode	RF mode	RF mode	RF mode
System on chief solution	Yes	Yes	Yes
Encryption	128 bit AES	No	64-bit ciphering key (Kc).
Data rate	20KBPS	20-200KBPS	96KBPS
Two way communication	Yes	Yes	Yes
Transmission range	60m	30m	AsPer requirement
No of Certified devices	<500	>600	AsPer requirement
Ability to work as a repeater	Yes	No	Yes
Performance index	0.792	0.375	0.80
Affordability Index	0.121	1.00	0.125

**Table 1** Review of different protocol

**III. System Overview**

Fig 2 demonstrates the reason framework piece outline. In this venture mix of the Implanted framework and Systems administration framework GSM framework utilized as a part of this venture to interface the our installed framework with ongoing framework. Mix of Arduino IC and GSM module are the principle part of our framework. With the assistance of this framework mortgage holder can get ready about home apparatuses status. In this framework fundamentally concentrate on the controlling, observing apparatuses and security framework.

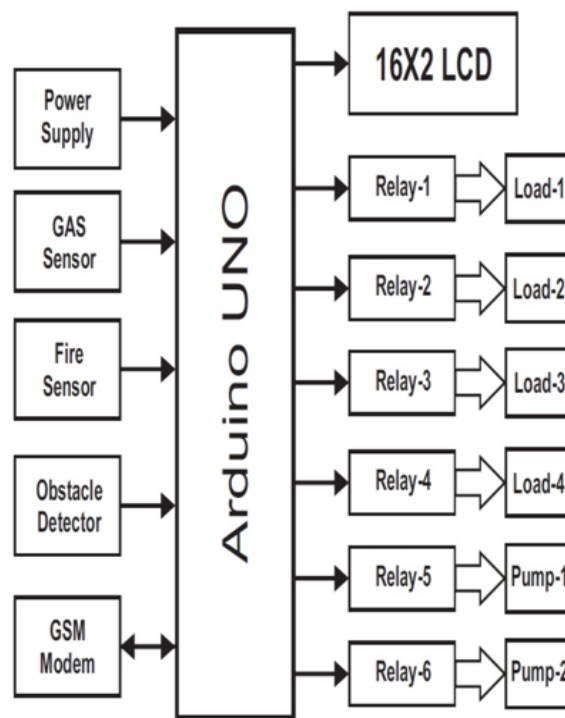

**Fig 2,** Block Diagram of Home Automation System

- 1 Fire sensor
- 2 LDR
- 3 Obstacle Detect
- 4 Pump controlling system
- 5 controlling the light, Fan and other equipment

Main advantage of this system all this application are gives on a one platform. A Communication system GSM The GSM is a superb decision in setting up a correspondence from remote areas where Web may not be accessible. The correspondence between the client and the house is built up by the SMS (Short Message Administration) convention. A GSM modem is associated with the home Automation server. The correspondence between the home mechanization server and the GSM modem is done by the AT (Consideration) orders. Sending and getting SMS messages are altogether performed in the PDU (Convention Depiction Unit) mode since the content mode may not be accessible on all GSM modules. If there should be an occurrence of cell phone in this framework no spatial programming writing computer programs is not required framework straightforwardly speak with SIM (Supporter Personality Module). Which is use in our day today life, because of no spatial insolation cost required. What's more, subsequently our framework is helpful to basic man. The details of the "ON OFF LIGHT" command is as follows

1. An SMS message is created which has a content of "light is on" command in an encrypted way.
2. This message is sent to the GSM modem
3. We can control devices through SMS and calling

A similar system is additionally used to advise the client about a status change in any gadget. The criticism status is a fundamental building square of the home mechanization framework. For instance, if a movement is identified, this data is sent from the movement sensor specifically to the home mechanization server. At that point a notice SMS message is made and sent quickly to the enlisted GSM number in the framework.

## **SYSTEM ELEMENT+**

### **1 Fire Sensor circuit**

Fig (9) shows the fire sensor circuit with help of this circuit our system gives the fire alert with the help of GSM system to the fire brigade The Fire sensor, as the name suggests, is used as a simple and compact device for protection against fire. The module makes use of IR sensor and comparator to detect fire up to a range of 1 meter The device, weighing about 5 grams, can be easily mounted on the device. It gives a high output on detecting fire. This output can then be used to take the requisite action. An on-board LED is also provided for visual indication

### **2 LPG Gas detector circuit**

Fig (4) shows the LPG Gas detector circuit with the help of this circuit our system gives the alert if in house gas is leakage at that time system gives alert to the owner with the help of GSM system. And with the help of SMS off the gas button. Sensitive material of MQ-6 gas sensor is SnO<sub>2</sub>, which with lower conductivity in clean air. When the target combustible gas exists, the sensor's conductivity is higher along with the gas concentration rising. Please use simple electro circuit, Convert change of conductivity to correspond output signal of gas concentration. MQ-6 gas sensor has high sensitivity to Propane, Butane and LPG, also response to Natural gas. The sensor could be used to detect different combustible gas, especially Methane, it is with low cost and suitable for different application.

### **3 Obstacle Detector circuit**

Fig (10) shows the Obstacle Detector circuit with the help of this circuit our system gives the alert to owner if any unknown person enters in home. Send the SMS to owner. The TSOP-OBSD-Single is a general purpose proximity sensor. Here we use it for collision detection. The module consists of a IR emitter and TSOP receiver pair. The high precision TSO receiver always detects a signal of fixed frequency. Due to this, errors due to false detection of ambient light are significantly reduced. The module consists of 555 IC, working in a stable multivibrator configuration. The output of TSOP is high whenever it receives a fixed frequency and low otherwise. The on-board LED indicator helps user to check status of the sensor without using any additional hardware. The power consumption of this module is low. It gives a digital output and false detection due ambient light is low.

#### 4 controlling Home Appliances

In this home automation system, we can control the home appliances. If we forget the switch off the button of any appliances at that time that devices we can control with the help SMS and Calling. In this System is design like that if owner is call on contact Number which SIM insert in GSM module. Automatically call is received and with help of mobile Key Pad can control the device. In our system if we press key 1 for off the first load and like that we can manage all load which are connected in system. All this devices control set I programming. As per requirement we can easily change in programming hence this system is effective in all point of view.

#### 4 Arduino module

Fig (6) shows the Arduino IC module It is heart of our project with of this IC all sub circuit and GSM module isinterface with the each other The Arduino Uno is a microcontroller board based on the ATmega328 (datasheet). It has 14 digital input/output pins (of which 6 can be used as PWM outputs), 6 analog inputs, a 16 MHz ceramic resonator, a USB connection, a power jack, an ICSP header, and a reset button. It contains everything needed to support the microcontroller; simply connect it to a computer with a USB cable or power it with a AC-to-DC adapter or battery to get started. The Uno differs from all preceding boards in that it does not use the FTDI USB-to-serial driver chip. Instead, it features the Atmega16U2 (Atmega8U2 up to version R2) programmed as a USB-to-serial converter.

#### 5 GSM Module

Fig (5) shows the GSM Nodule

GSM/GPRS MODEM is a class of wireless MODEM devices that are designed for communication of a computer with the GSM and GPRS network. It requires a **SIM (Subscriber Identity Module)** card just like mobile phones to activate communication with the network. Also they have **IMEI (International Mobile Equipment Identity)** number similar to mobile phones for their identification. A GSM/GPRS MODEM can perform the following operations:

1. Receive, send or delete SMS messages in a SIM.
2. Read, add, search phonebook entries of the SIM.
3. Make, Receive, or reject a voice call.

The MODEM needs **AT commands**, for interacting with processor or controller, which are communicated through serial communication. These commands are sent by the controller/processor. The MODEM sends back a result after it receives a command. Different AT commands supported by the MODEM can be sent by the processor/controller/computer to interact with the **GSM and GPRS cellular network**.

#### SOFTWARE USED

In this Home Automation System referred basic programming Language 'C'. and GSM Module programming to set AT command for controlling devices. Flow of system is shown Flow Chart.

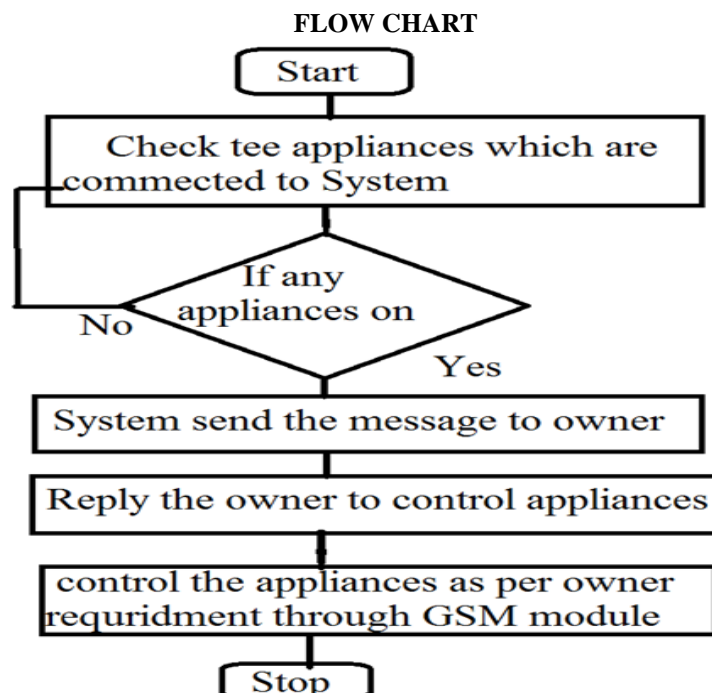

Flow chart shows the how Home automation system software programming flow. When system start to monitor the home appliances at requirement we want to on or off we can control from any place. Suppose any electric appliances is on at home In this system design transceiver part of the system transmit the signal on home owner mobile through GSM Module. Home owner take action on it and transfer the signal with help of mobile phone to turn off device This signal receives by the transceiver part of the system and with help of Arduino microcontroller turn off the device. Security system is also activated when thief is entering at home at that time also home owner receives the system message. In our project. In our project different sensor are used and because of that sensor other indication gives to owner



**Fig (3)** Home Automation System Modal



**Fig (5)** GSM Module

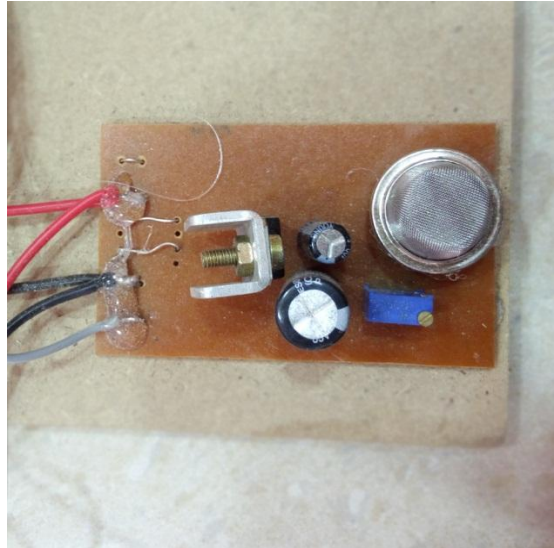

Fig(4) LPG Gas Sensor Circuite

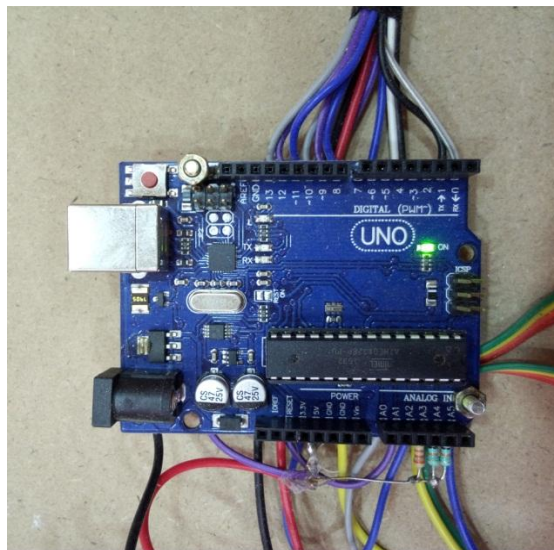

Fig (6) Arduino IC Module



Fig(7) LCD Display

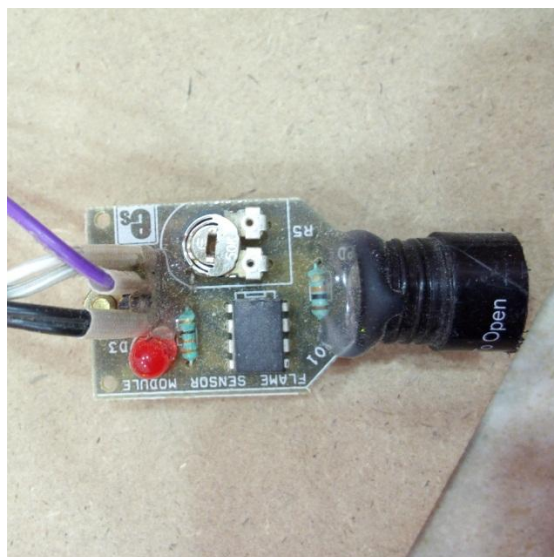
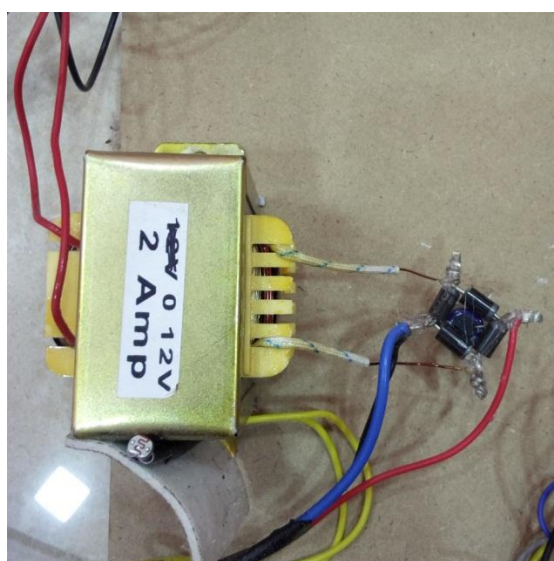
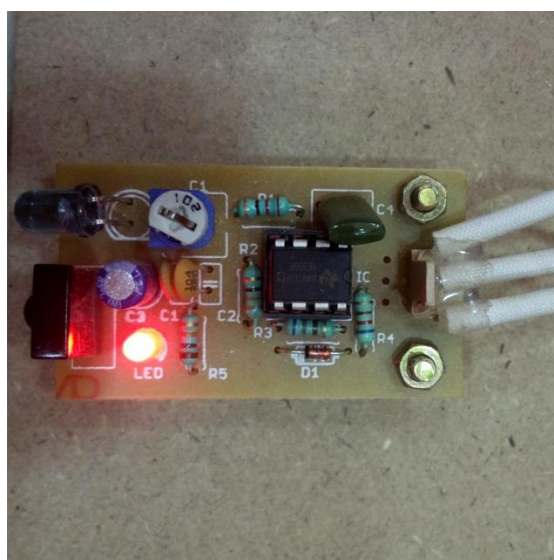

Fig9) Fire Sensor



Fig(8) Step-dow transformer



Fig(10) Obstracal Sensor



#### IV. Result

Implemented system is beneficial to other home Automation system because our system is compared with other Home Automation System our system is comparatively better in terms of hardware and software. Implemented system is compact modal of different subcircuits and GSM module and Arduino. Our System is compared with different home Automation system (Java programming Home Automation System) In this system Difficult to design the system and in case of cost analysis our project is efficient In case of Hardware our system is very effective and easy to handle. Compact module to different work. In House any Gas leakage is detected at the same time LPG Gas Sensor senses the Gas and send Message to house owner mobile phone

##### Test 1 ON-OFF Equipment

When we are outside the home at that time we control the equipment which are connected in system. In our system if we press '1' on the load and press '0' off the load

##### Test 2 Fire Sensor

When fire detected at home which is greater than threshold (light and temperature set in program) at that time system send the message to firebrigade.

##### Test 3 security System

If thief is enter at home and he open the locker at that time capture the image and send the message and photo to house owner and police station with the help of GSM module

##### Test 4 Gas Detector

At home Gas is detected greater than threshold value set in program at that time system send the message to owner and owner can control the Gas leakage with sending message.

##### Test 5 curtains control

As per requirement we can control the curtains with help of mobile message or RF remote controller

##### Test 6 Water Pump overflow controller and detector

This system is indicate the water level and if water overflow We can control the water tap with the help of mobile phone message.

#### V. Conclusion

This paper displays the plan and the execution of an intuitive home robotization framework with the GSM, The Web gives get to the full elements of the framework through an intelligent Web interface. As the versatility on the planet expands, the need to control home from remote areas additionally increments. The GSM is an astounding decision for this because of its broad scope. Since SMS is a content based convention, even the most fundamental GSM frameworks can have an entrance to the status of the gadgets or roll out improvements on these states. The outline is totally remote and coordinated with the product to shape a minimal effort, hearty. The multi-esteem alteration highlight is another solid point in the framework empowering the gadgets to have unmistakable states rather

#### References

- [1] Manouchehr Gbahrmanian et.al "A new intelligent Remote control System for human Automation system for home Automation System and Reduce energy consumption"Fourth Asia International Conference on Mathematical Analytical Modelling and computer simulation pp 174-180,2010
- [2] M Van De, weff X Gui and W.L Xu 'mobile based home Automation System 2<sup>nd</sup> international conference on mobile technology Application and System pp 1-5,2015
- [3] Kyu Hwang et.al "Home Network configuring Scheme for all Electronics appliances using Zigbee based integrated remote controller IEEE Transaction on consumer electronics Vol 55 No 3 pp 1300-1307 August 2009
- [4] Hyung bong Lee et.al "interactive remote control of legacy home appliance through a virtually wired Sensor network" IEEE Transaction on consumer Electronics vol 56 No 4, pp 2241-2248 2010
- [5] Fabio. L. et.al "ZigBee for building Control wireless sensor network" IMOC 2017 SBMOIEEE MTT-S international Microwave and optoelectronics conference pp 511-515,2007
- [6] Kwang Koog Lee et.al "a mesh routing protocol using cluster label in the ZigBee Network" IEEE international conference on mobile Adhoc and sensor system pp 801-806 2006
- [7] Atmel 8 bit AVR Microcontroller Atmega128 from [http://www.atmel.com/dyn/resources/prod\\_documents/doc2467.pdf](http://www.atmel.com/dyn/resources/prod_documents/doc2467.pdf)
- [8] A.R Al-Ali member, IEEE M.AL Rousan "Java based home Automation System" IEEE Transactions on consumer Electronics Vol 50, No 2, May 2004
- [9] Baris Yuksekkaya et.al "GSM Internet and speech controlled wireless Interactive home Automation System"IEEE Transaction on consumer Electronics vol 52, August 2006

IOSR Journal of Electrical and Electronics Engineering (IOSR-JEEE) is UGC approved Journal with SI. No. 4198, Journal no. 45125.

Gauri Sunil Kakade. "Home Automation System And Security System Using GSM." IOSR Journal of Electrical and Electronics Engineering (IOSR-JEEE) 12.4 (2017): 78-86.